

Detalles de producto referencia CAI200HA2110VIN

Sumidero industrial telescópico de 200x200 mm para pavimentos vinílicos, con salida horizontal Ø110 mm. Con dos cuerpos redondeados, sifónico, con cesta de recogida de sólidos y tapa/reja extraíbles. El sifón puede utilizarse con o sin cesta de sólidos. La cesta de recogida de sólidos es adecuada para sumideros con o sin sifón extraíble.

Material:

Fabricado en acero inoxidable AISI 304 o 316L.
Acabado decapado.

Caudal de evacuación:

3,2 l/s

Datos técnicos:

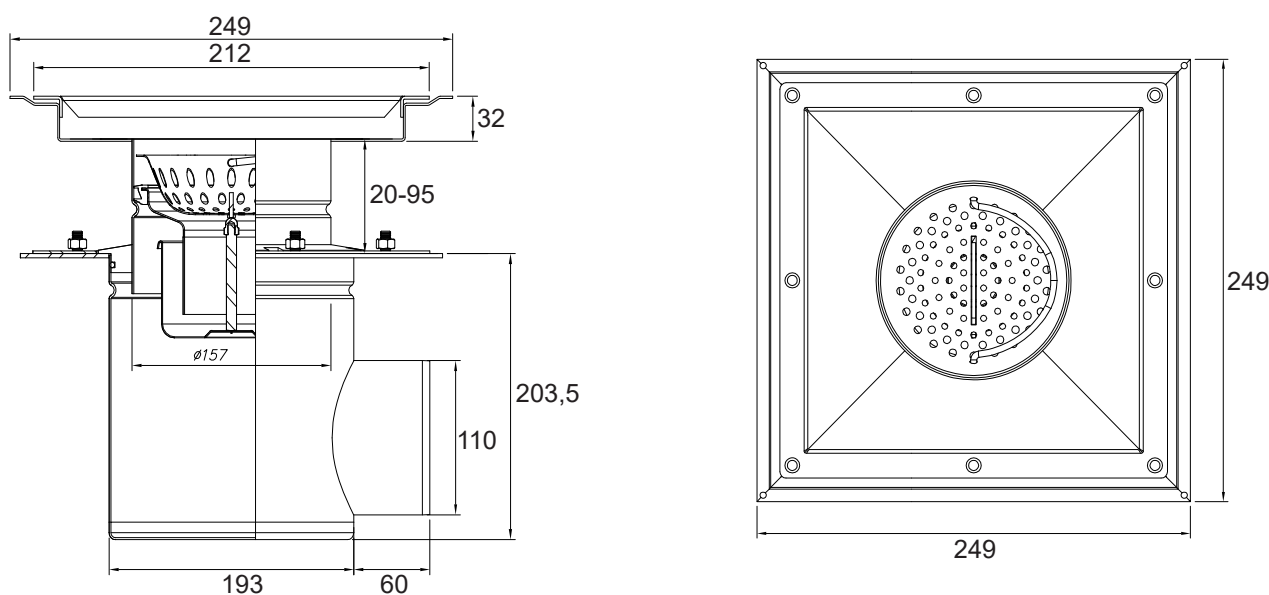

Tipos de reja:

RA11

RA13

RA13 ANTI

RA14

RA15

RA15 ANTI

RA18

RA18 ANTI



Perforada
Antideslizante
Carga L

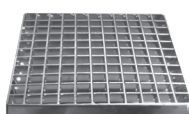

Entramada Lisa
Carga L

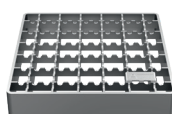

Entramada
Antideslizante
Carga L



Ranurada
Clase M



de Pletinas
Clase M



de Pletinas
Antideslizante
Clase M



Higiénica Lisa
Tráfico Ligero



Higiénica
Antideslizante
Tráfico Ligero